

2026

www.swstahl.de

TOOLNEWS FOR PROFESSIONALS SPECIAL

WHEEL & TIRE SPRING



6 | IMPACT
WRENCH

14 | OUR PROFESSIONAL
TORQUE WRENCHES

34 | JACK

READY FOR THE PIT STOP!

SW STAHL
PROFESSIONAL TOOLS

THE COMPLETE TT SERIES



TT800

TT400

TT200

TB4000 & TB2000

TOOLBOARDS FOR MORE ORDER. MORE EFFICIENCY. MORE POWER.



HERE
YOU CAN FIND
MORE INFOR-
MATION

TB 4000
TOOLBOARD **MECHANIC**



ART: 040002

1.999,⁹⁰ *€

TB 4000
TOOLBOARD **BEGINNER**



ART: 040001

1.750,⁹⁰ *€

TB 2000
TOOLBOARD **BEGINNER**



ART: 020001

1.499,⁹⁰ *€

SW STAHL MAGNETIC HOLDER FOR IMPACT WRENCH

- Compatible with all standard impact wrenches and cordless drill drivers
- Robust rubber coating: Durable protection for the tool thanks to rubber coating
- Rubberised magnet prevents scratches on surfaces
- Vertical load capacity of 14 kg, depending on the surface finish
- Ideal for workshop trolleys and all metal surfaces



07550L 20,90 EUR*

SW STAHL PNEUMATIC IMPACT WRENCH, 1/2", 1,756 NM

- 12.5 mm (1/2") drive.
- High-performance twin hammer mechanism
 - Extremely lightweight and easy to hold for long periods of time without tiring
 - Function for switching between clockwise /anti-clockwise running
 - Very quiet; protects hearing
 - Very low-vibration
 - 3 torque settings
 - With non-slip handle
 - Includes 6.3 mm (1/4") pneumatic connector



S3276 156,90 EUR*

SW STAHL PNEUMATIC STUBBY IMPACT WRENCH, 1/2", 1,300 NM

- 12.5 mm (1/2") drive.
Ideal for loosening the high-tensile fitting of half-shaft screws on single sided swing arms of motorcycles, especially Ducati and MV Agusta.
- Very short design
 - High performance twin hammer mechanism
 - Fatigue-proof work due to extremely low net weight
 - Very quiet
 - Very low vibration
 - With a non-slip handle
 - 6,3 mm (1/4") inlet nipple included



S3284 138,50 EUR*

SW STAHL PNEUMATIC IMPACT WRENCH, 1/2", 1,300 NM

- 12.5 mm (1/2") drive.
- High-performance twin hammer mechanism
 - Extremely lightweight and easy to hold for long periods of time without tiring
 - Function for switching between clockwise /anti-clockwise running
 - Very quiet; protects hearing
 - Very low-vibration
 - 3 torque settings
 - With non-slip handle
 - Includes 6.3 mm (1/4") pneumatic connector



S3275 156,90 EUR*

SW STAHL PNEUMATIC IMPACT WRENCH, 3/4", 3,200 NM

- 20 mm (3/4") drive.
- High-performance twin hammer mechanism
 - Very light aluminium housing
 - Very quiet; protects hearing
 - Low-vibration
 - 3 torque settings
 - With non-slip handle
 - Includes 10 mm (3/8") pneumatic connector



S3277 313,50 EUR*

SW STAHL PNEUMATIC IMPACT DRIVER, 1", 3200 NM

- 25 mm (1") drive.
- High-performance twin hammer mechanism
 - Very light aluminium housing
 - Very quiet; protects hearing
 - Low-vibration
 - 3 torque settings
 - With non-slip handle
 - Includes 10 mm (3/8") pneumatic connector



S3278 313,50 EUR*

SW STAHL PNEUMATIC RATCHET WRENCH, 1/4", 41 NM

- Fatigue-proof work as a result of extremely low net weight
- Very quiet
- Rear exhaust
- Cold insulated and anti-slip handle
- Very low-vibration



S3281 56,90 EUR*

SW STAHL PNEUMATIC RATCHET WRENCH, 3/8", 41 NM

- Ratchet head protected against dirt
- Easy to switch (left / right)
- Rear exhaust
- Cold insulated and anti-slip handle
- Includes 6.3 mm (1/4") pneumatic connector



S3282 56,90 EUR*

SW STAHL PNEUMATIC IMPACT RATCHET WRENCH, 1/2", 122 NM

This impact ratchet wrench with pin clutch impact mechanism is perfect for loosening and tightening very tight screw connections.

Special features:

- Pin clutch impact mechanism
- Non-rebound mechanism for low impact work
- Cold insulated and non-slip handle
- Easy to switch (left / right)
- Includes 6.3 mm (1/4") pneumatic connector



S3290 167,00 EUR*

SW STAHL PNEUMATIC RATCHET WRENCH, 1/2", 68 NM

- Fatigue-proof work as a result of extremely low net weight
- Gentle on hearing due to low sound pressure levels
- Rear exhaust
- Cold insulated and anti-slip handle
- Very low-vibration



S3283 71,00 EUR*

SW STAHL PNEUMATIC ANGLE IMPACT WRENCH, 1/2", 450 NM

12.5 mm (1/2") drive.

- With extremely low design height of 69 mm, for spots that are hard to reach
- Jumbo hammer mechanism for undoing screws that are stuck
- Extremely lightweight (1.16 kg) and easy to hold for long periods of time without tiring
- Single-handed switching for clockwise/anti-clockwise running
- 3 torque settings for clockwise running
- Includes 6.3 mm (1/4") pneumatic connector



S3296 135,90 EUR*

SW STAHL PNEUMATIC AXIAL GRINDER, 1/4", STRAIGHT

for grinding, milling, deburring etc., with 6 mm collet chuck.

- Inc. 6.3 mm (1/4") pneumatic connection incl. plug nipple
- Max. 22,000 rpm
- Exhaust air outlet at the rear
- Safety lever prevents unintentional switch-on



S3260 31,50 EUR*

SW STAHL PNEUMATIC AXIAL GRINDER, 1/4", 90° ANGLED

for grinding, milling, deburring etc., with 6 mm (1/4") collet chuck.

- Inc. 6.3 mm (1/4") pneumatic connection incl. plug nipple
- Max. 18,000 rpm
- Exhaust air outlet at the rear
- Safety lever prevents unintentional switch-on



S3265 41,90 EUR*

SW STAHL PNEUMATIC AXIAL GRINDER SET, 1/4", 17-PIECE

ultra compact, with 10 grinding stones and oil spray device. For use in spots that are difficult to access, for machining intake ducts etc. in the tuning sector.

- Axis diameter of the grinding and milling heads 3 mm
- Only 135 mm long (without hose), 16 mm diameter
- Very low in weight - less than 200 g (without hose)

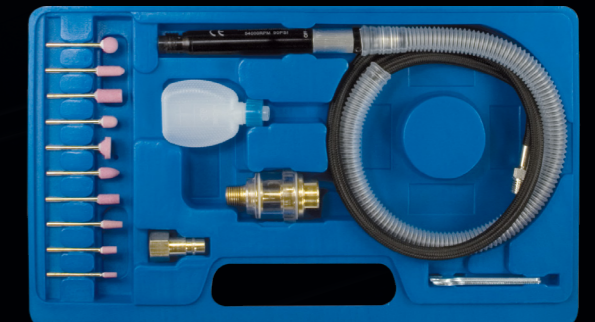

S3263 35,50 EUR*

SW STAHL PNEUMATIC BIT IMPACT WRENCH, 1/4", 110 NM

- With 110 Nm loosening torque
- Hexagon drive: 6.3 mm (1/4")
- Maximum speed: 13,000 rpm.
- Single-handed switching for clockwise/anti-clockwise running
- Includes 6,3 mm (1/4") inlet nipple



S3231 39,50 EUR*

SW STAHL COMPRESSED AIR MAINTENANCE UNIT

The compressed air service unit consists of a pressure regulator, water trap and oil-fog lubricator (12.5 mm (1/2"))

- Maintenance unit with connection for air supply and 2 quick couplings incl. pressure gauge
- Air pressure in the intake: max. 15 bar
- Adjustment range of the regulator: 0.5 ~ 11 bar
- Flow rate: 3,100 l/min



25029L 94,00 EUR*

SW STAHL WINDING DRUM FOR COMPRESSED AIR HOSE, 1/2", 15 M

Suitable for wall and ceiling mounting, PVC hose with adjustable hose stopper.

- Hose lockable at 0.1 m intervals when unreeled
- 0.5 m hose connector
- 15 m usable hose
- Complete with 1/4" quick couplings
- With automatic recoil mechanism
- Internal hose diameter: 12.5 mm
- External hose diameter: 18.8 mm



25061L 104,50 EUR*

SW STAHL CORDLESS IMPACT WRENCH, 1/2", 900 NM, 18V

The new, battery-operated impact driver from SW-Stahl combines high torque with the latest technology. Special equipment:

- Maintenance-free brushless motor (30% more efficient than a brushed motor)
- Longer running time without any change in battery capacity
- 2x Li-Ion batteries, 18 V - 5 Ah
- Batteries with level indicator
- Bright LED illumination of the work environment; light goes off after 15 seconds of non-use



S3300 360,50 EUR*

SW STAHL AUTOMATIC OILER

with 6.3 mm (1/4") threaded connection

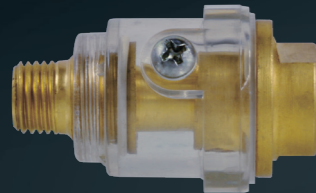

25046L 6,20 EUR*

SW STAHL PNEUMATIC HELICAL HOSE, 10 M

with nickel-plated quick couplings.

- Internal hose diameter: 10 mm
- External hose diameter: 14 mm
- Total length (extended): 10 m
- Material: Polyurethane
- Working pressure: 6.9 bar / 100 psi
- Bursting pressure: 20.7 bar / 300 psi
- Connecting thread: 10 mm (3/8")



25051L 31,50 EUR*

SW STAHL HOSE FOR COMPRESSED AIR, INNER DIAMETER 6 MM, 10 M

with quick-action couplings.



25045L 12,50 EUR*

SW STAHL PNEUMATIC HELICAL HOSE, INNER DIAMETER 6 MM, 10 M

with quick-action couplings.



25040L 19,80 EUR*

SW STAHL REPLACEMENT BATTERY 18 V

- Short charging time – only 1 hour
- With LED status indicator



S3300-AKKU 137,90 EUR*

TOOL-IS

DON'T SEARCH. FIND!

www.tool-is.com
COME BY AND SEE FOR YOURSELF!

No more hide-and-seek: there's nothing worse than needing a tool and not being able to find it, or only having a vague memory of where it is. We know how that feels. That's why we invented **TOOL-IS**: the online tool search engine from SW Stahl.

TOOL-IS can now do even more. Or rather, you can do even more. You can now use **TOOL-IS** on mobile devices (i.e., smartphones or tablets). Availability, promotion periods, and prices are displayed in real time—it couldn't be more up-to-date or faster. What's more, thanks to the various search options, you're sure to find what you're looking for—even if you only have a few clues to go on.

- ⊗ Fast and flexible online tool search
- ⊗ Display of availability, promotional periods, prices, and more in real time
- ⊗ Can also be used on smartphones and tablets
- ⊗ Quick search with automatic search suggestions
- ⊗ Keyword and full-text search
- ⊗ Search by OE numbers, engine codes, item numbers, or vehicle types
- ⊗ German, English, and French
- ⊗ Create watch lists

HOTLINE

SW STAHL
PROFESSIONAL TOOLS

TECHNOLOGY

+49 (0) 21 91 / 464 38 -55

COMMERCIAL SERVICE

+49 (0) 21 91 / 464 38 -45



REGISTER NOW AND
VIEW ADDITIONAL CONTENT!



SW STAHL TORQUE WRENCH, 1/2"

NEW
PRODUCT

- Calibrated torque wrench with certificate and serial number
- Accuracy of $\pm 3\%$
- For the controlled right tightening
- With reversible ratchet head
- Practical direct numerical display of the desired torque value
- Secure locking by locking the rotary knob
- Extra fine scale graduation
- Ergonomically designed 2-component handle
- „Designed in Germany“



40-220 NM

03890L 49,00 EUR*

60-340 NM

03891L 54,90 EUR*



SW STAHL PROFESSIONAL TORQUE WRENCH, 1/2"

- Calibrated torque wrench with certificate and serial number
- Accuracy of $\pm 4\%$
- For the controlled right tightening
- With reversible ratchet head
- Direct numerical display of the desired torque value
- Secure locking of the rotary handle by means of push-button
- Extra fine scale graduation
- Ergonomically designed 2-component handle
- Service-friendly as repair kits are available

20-100 NM

03873L 89,90 EUR*

40-200 NM

03874L 89,90 EUR*

60-340 NM

03875L 119,90 EUR*

DESIGNED
IN GERMANY

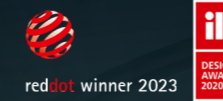

SW STAHL PROFESSIONAL TORQUE WRENCH,
1/4", 5-25 NM

- Calibrated torque wrench with certificate and serial number
- Accuracy of $\pm 4\%$
- For the controlled right tightening
- With reversible ratchet head
- Direct numerical display of the desired torque value
- Secure locking of the rotary handle by means of push-button
- Extra fine scale graduation
- Ergonomically designed 2-component handle
- Service-friendly as repair kits are available



DESIGNED
IN GERMANY

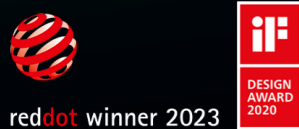

03871L 99,90 EUR*

SW STAHL PROFESSIONAL TORQUE WRENCH, 3/8",
10-50 NM

- Calibrated torque wrench with certificate and serial number
- Accuracy of $\pm 4\%$
- For the controlled right tightening
- With reversible ratchet head
- Direct numerical display of the desired torque value
- Secure locking of the rotary handle by means of push-button
- Extra fine scale graduation
- Ergonomically designed 2-component handle
- Service-friendly as repair kits are available



DESIGNED
IN GERMANY

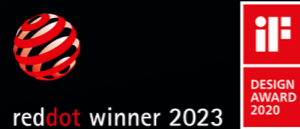

03872L 99,90 EUR*

SW STAHL PROFESSIONAL TORQUE WRENCH, 3/4"

DESIGNED
IN GERMANY

- Calibrated torque wrench with certificate and serial number
- Accuracy of $\pm 4\%$
- For the controlled right tightening
- With reversible ratchet head
- Direct numerical display of the desired torque value
- Secure locking of the rotary handle by means of push-button
- Extra fine scale graduation
- Ergonomically designed 2-component handle
- Service-friendly as repair kits are available



110-550 NM

03876L 499,90 EUR*

150-750 NM

03877L 499,90 EUR*



SW STAHL
**PROFESSIONAL TORQUE WRENCH,
1", 200-1,000 NM**



- Calibrated torque wrench with certificate and serial number
- Accuracy of ± 4%
- For the controlled right tightening
- With reversible ratchet head
- Direct numerical display of the desired torque value
- Secure locking of the rotary handle by means of push-button
- Extra fine scale graduation
- Ergonomically designed 2-component handle
- Service-friendly as repair kits are available

DESIGNED
IN GERMANY

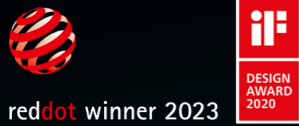

03878L 599,90 EUR*

SW STAHL
**GARAGE TORQUE WRENCH WITH WHEEL
NUT SOCKETS, 1/2", 40-200 NM, 4-PIECE**



- Calibrated torque wrench with certificate and serial number
- Accuracy of ± 4%
- For the controlled left and right tightening
- Ratchet head with push-through square (mushroom head)
- Clearly visible torque scale

Content:

- Garage torque wrench 12.5 mm (1/2"), 40-200 Nm
- Wheel nut sockets with sizes 17 mm, 19 mm and 21 mm



03879L 79,90 EUR*

SW STAHL
**PROFESSIONAL TORQUE WRENCH WITH
RING WRENCH INSERTS AND REVERSIBLE
RATCHET INSERT, 40-200 NM, 9-PIECE**



- Calibrated torque wrench with calibration certificate and serial number
- 14 x 18 mm plug-in connection for plug-in tools
- Direct numerical display of the desired torque value

Content:

- Professional torque wrench with square insert, 14x18 mm, 40-200 Nm
- Reversible ratchet insert 12,5 mm (1/2")
- Ring wrench inserts with sizes 13, 15, 16, 17, 18, 19, 21 mm

03880L 279,90 EUR*

SW STAHL
**PROFESSIONAL TORQUE WRENCH, WITH
SQUARE INSERT, 40-200 NM**



- 14 x 18 mm plug-in connection for insert tools
- Head can be replaced in seconds
- Calibrated torque wrench with calibration certificate and serial number
- Accuracy of ± 4%
- Direct numerical display of the desired torque value
- Secure locking of the rotary handle with a push button
- Extra fine scale graduation
- Ergonomically designed 2-component handle
- Service-friendly as repair kits are available
- Wide range of optionally available insert tools

DESIGNED
IN GERMANY

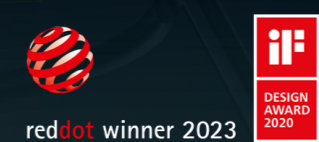

03870L 139,90 EUR*

SW STAHL
**GARAGE TORQUE WRENCH, 1/2",
40-200 NM**



- Calibrated torque wrench with certificate and serial number
- Accuracy of ± 4%
- For the controlled left and right tightening
- Ratchet head with push-through square (mushroom head)
- Clearly visible torque scale
- Extra fine graduation (+/- 1 Nm)
- Secure locking of the rotary handle
- Ergonomically designed 2-component handle
- Service-friendly as repair kits are available

DESIGNED
IN GERMANY



03884L 69,90 EUR*

SW STAHL
**GARAGE TORQUE WRENCH, 1/2",
60-340 NM**



- Calibrated torque wrench with certificate and serial number
- Accuracy of ± 4%
- For the controlled left and right tightening
- Ratchet head with push-through square (mushroom head)
- Clearly visible torque scale
- Extra fine graduation (+/- 1 Nm)
- Secure locking of the rotary handle
- Ergonomically designed 2-component handle
- Service-friendly as repair kits are available

DESIGNED
IN GERMANY

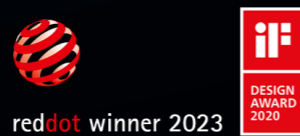

03885L 99,90 EUR*

SW STAHL
TORQUE WRENCH, 1/4"



- Calibrated torque wrench with certificate and serial number
- Left and right-handed
- With switchable ratchet head
- Double scale Ft-LB
- Extra-fine scale division
- Secure locking of the rotary handle
- Service-friendly as repair kits are available

2-10 NM

03809L 106,00 EUR*

5-25 NM

03810L 106,00 EUR*

SW STAHL
TORQUE WRENCH, 1/2"



- Calibrated torque wrench with certificate and serial number
- Left and right-handed
- With switchable ratchet head
- Double scale Ft-LB
- Extra-fine scale division
- Secure locking of the rotary handle
- Service-friendly as repair kits are available

40-200 NM

03807L 106,00 EUR*

60-340 NM

03821L 106,00 EUR*

SW STAHL
**TORQUE WRENCH, 3/4",
110-550 NM**



- Calibrated torque wrench with certificate and serial number
- For clockwise and anti-clockwise tightening
- With changeable ratchet head
- Double scale Ft-LB
- Extra-fine dial division
- Secure interlocking of the turn grip
- Service friendly, since repair sets are available

03822L 212,00 EUR*

**SW STAHL TORQUE WRENCH, 3/8",
19-110 NM**

switchable, set value can be locked, in plastic box.



03905L 106,00 EUR*

**SW STAHL TORQUE WRENCH, 1/2",
40-210 NM**

12.5 mm (1/2") drive

- Switchable
- Set value can be locked
- Accuracy +/- 4% of the given scale value
- Serial number and certificate



03933L 106,00 EUR*

**SW STAHL CROSS BAR FOR WHEEL NUT WRENCHES,
600 MM**

for wheel nut wrenches

- diameter 22 mm
- length 600 mm
- made of high-quality chrome vanadium steel



02242L 15,60 EUR*

SW STAHL WHEEL NUT WRENCH, 1/2", 17-19-21 MM

- With reinforced central plate
- Leg length 170 mm



02100L 10,40 EUR*

**SW STAHL TORQUE REPRODUCER, 1", 3,200 NM,
5-PIECE**

to release jammed wheel nuts on lorries and vans. 25 mm (1"), input and output with extension, crank and inserts 32, 33 mm. Transferrable torque: 3,200 Nm Even completely jammed or rusted wheel nuts are loosened easily; the nut is then removed quickly or refitted using a crank and extension.



03966L 148,50 EUR*

SW STAHL TORQUE WRENCH, 1/4", 5-25 NM

switchable, set value can be locked, in plastic box.



03920L 42,50 EUR*

**SW STAHL T-HANDLE TORQUE WRENCH WITH BITS,
2-8 NM, 13-PIECE**

- Ideal for tightening with low torque
- Adjustment range: 2-8 Nm, in 0.1 Nm increments
- Easily legible scale
- 1/4" hexagonal drive
- Magnetic function
- With handy plastic handle

Scope of delivery:

- T-handle torque wrench, 2-8 Nm
- 12 bits



03913L 74,00 EUR*

SW STAHL WHEEL NUT WRENCH

based on DIN 3119

- extremely stable design made from high-quality chrome vanadium
- with 22 mm turning pin (length 600 mm)
- matt chrome plated
- in practical fabric bag



27 X 32 MM

02247L 36,50 EUR*

30 X 32 MM

02251L 36,50 EUR*

SW STAHL WHEEL NUT WRENCH

based on DIN 3119

- extremely stable design made of high-quality chrome vanadium steel.
- mat chrome-plated.

24 X 27 MM

02220L 15,60 EUR*

27 X 32 MM

02222L 18,70 EUR*

30 X 32 MM

02226L 20,90 EUR*



**SW STAHL WHEEL NUT WRENCH, 13/16",
17-19-22 MM, PASSENGER CAR**

- According to DIN 3119
- Leg length 170 mm



02102L 10,40 EUR*

**SW STAHL WHEEL NUT WRENCH, 3/4", 24-27-32 MM,
TRUCKS**

- With reinforced central plate
- Leg length 350 mm



02450L 37,50 EUR*

SW STAHL SPECIAL TOOL FOR CENTRAL LOCKING, 3/4", PORSCHE

for Porsche wheel bolts with central locking. Suitable for the following Porsche models: 991/997 / GT2 / GT3. With 20 mm (3/4") drive and tightening torque over 500 Nm. Used equivalent to the following OE numbers:

- 991.361.069.00



07866L 135,90 EUR*

SW STAHL SPECIAL WHEEL NUT SOCKETS, FORD, 2-PIECE

Special tool set for wheel nuts with stainless steel caps, as often used by Ford. Over time the stainless steel caps get lost and normal wheel nut sockets are then too big for the wheel nuts and damage the hexagon. The set includes 2 special wheel nut sockets with sizes 18.5 / 19.5 / 20.5 and 21.5 mm.



07884L 26,00 EUR*

SW STAHL WHEEL NUT SOCKET, 1/2", 21 MM, LONG

Suitable e.g. for Hyundai and Kia.

- Impact-resistant
- Star profile
- Fully plastic encapsulated
- Optimum force transmission
- Protects against scratches on rims



07888SB 10,40 EUR*

SW STAHL WHEEL NUT SOCKET, 1/2", 7/8" TESLA

- Spanner width 7/8"
- Especially for Tesla Model S and Model X of the first generation
- Impact-proof
- Fully plastic-encapsulated to ensure alloy wheels are no longer scratched



07891L 8,20 EUR*

SW STAHL WHEEL NUT SOCKETS, 1/2", 17-21 MM, 3-PIECE

- Fully plastic-encapsulated
- Extra thin-walled
- Optimum power transmission

17 mm, 19 mm, 21 mm



07870L 15,60 EUR*

SW STAHL WHEEL NUT SOCKETS, 1/2", 15-22 MM, 5-PIECE

- Fully encapsulated in plastic
- Extra thin walls
- Optimum force transmission

15, 17, 19, 21, 22 mm



07865L 31,50 EUR*

SW STAHL WHEEL NUT SOCKET, 1/2", 17 MM, LONG

- Fully plastic-encapsulated
- Extra thin walled
- Optimal power transmission
- Rims and screws are no longer scratched
- Made of high-strength chrome molybdenum
- With groove and bore



07881L 15,60 EUR*

SW STAHL WHEEL NUT SOCKETS, 1/2", 17-21 MM, 3-PIECE, LONG

Special length, especially suitable for well-base rims.

- Fully plastic encapsulated
- Extra thin walled
- Optimum force transmission
- Impact-resistant

17 mm, 19 mm, 21 mm



07880L 41,90 EUR*

SW STAHL WHEEL NUT SOCKET, 1/2", 17 MM, DEEP

Especially for Mercedes-Benz.

- Impact-resistant
- Star profile
- Fully plastic encapsulated
- Optimum force transmission
- Protects against scratches on rims



07887L 10,40 EUR*

SW STAHL WHEEL NUT SOCKET, 1/2", 17 MM

- Impact-proof
- Fully encapsulated in plastic
- Extra thin walls, optimum force transmission
- Rims and bolts no longer become scratched

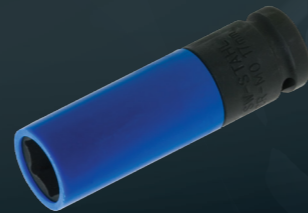

07871L 8,20 EUR*

SW STAHL WHEEL NUT SOCKET, 1/2", 19 MM, LONG

- Fully plastic-encapsulated
- Extra thin walled
- Optimal power transmission
- Rims and screws are no longer scratched
- Made of high-strength chromium molybdenum
- With groove and bore



07882L 15,60 EUR*

SW STAHL WHEEL NUT SOCKET, 1/2", 21 MM, LONG

- Fully plastic-encapsulated
- Extra thin walled
- Optimal power transmission
- Rims and screws are no longer scratched
- Made of high-strength chrome molybdenum
- With groove and bore



07883L 15,60 EUR*

SW STAHL WHEEL NUT SOCKET, 1/2", 19 MM

- Impact-proof
- Fully encapsulated in plastic
- Extra thin walls
- Optimum force transmission
- Rims and bolts no longer become scratched

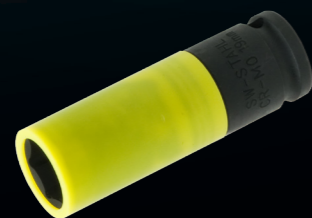

07872L 8,20 EUR*

SW STAHL WHEEL NUT SOCKET, 1/2", 21 MM

- Fully plastic-encapsulated
- Extra thin walled
- Optimal power transmission
- Rims and screws are no longer scratched
- Made of high-strength chrome molybdenum



07873L 9,30 EUR*

SW STAHL JACK MOUNT KIT, TESLA, 4-PIECE

- Especially for Tesla model 3, S, X, Y for safe lifting
- Non-slip, protects the battery and the underbody when lifting
- Perfect fit, made from robust and durable plastic
- Incl. storage bag



20732L 20,90 EUR*



SW STAHL **SPRIAL GROOVE SOCKETS, 1/2", 17-19-21 MM, 4-PIECE**

For releasing badly damaged wheel nuts and bolts.

- 150 mm sockets
- Sizes 17, 19, 21 mm
- Removal pin



07890L 34,90 EUR*

SW STAHL **WHEEL LOCK NUT SET, VW, 23-PIECE**

Replacement key for original wheel locks when the original key is no longer available or forgotten when changing the wheel. The key set allows the original lock nuts to be released and tightened without damage.



02382L 67,50 EUR*

SW STAHL **WHEEL LOCKS SOCKET SET, VW, 20-PIECE**

Replacement sockets for original wheel locks. Set allows the original lock nuts to be released and tightened without damage. Suitable for vehicles produced since 2012.



02383L 135,90 EUR*

SW STAHL **WHEEL LOCK REMOVER SET, MERCEDES-BENZ, 30-PIECE**

Replacement keys for original wheel locks; set allows the original lock nuts to be released and tightened without damage. Suitable for vehicles produced since 2012.



02385L 198,50 EUR*

SW STAHL **WHEEL LOCK NUT SET, BMW, 21-PIECE**

Replacement key for original wheel locks when the original key is no longer available or forgotten when changing the wheel. The key set allows the original lock nuts to be released and tightened without damage. Suitable for vehicles up to 2012.



02381L 73,00 EUR*

SW STAHL **WHEEL LOCK REMOVER SET, BMW, 20-PIECE**

Replacement keys for original wheel locks, allows the original lock nuts to be released and tightened without damage. Suitable for vehicles produced since 2012.



02384L 156,90 EUR*

SW STAHL **THREAD TAPPING SET FOR WHEEL BOLTS AND STUDS, 12-PIECE**

For cleaning and rethreading wheel bolts, threaded holes and studs on the wheel hub.

- M12 x 1,25 mm
- M12 x 1,50 mm
- M14 x 1,50 mm



02370L 125,50 EUR*

SW STAHL **PNEUMATIC TYRE FILLER, 0-15 BAR**

- Made of high-grade diecast aluminum
- With flexible hose 300 mm
- Gauge 270° (0 - 15 bar)



25030L 14,10 EUR*

SW STAHL **PNEUMATIC TYRE FILLER, 0-10 BAR**

European make, calibrated version according to Directive 86/217/EEC.

- Measuring/filling range 0 - 10 bar
- Rubber-encased gauge
- Length of filling hose approx. 530 mm
- Scale diameter 56 mm (visible)



25034L 73,00 EUR*

SW STAHL **PNEUMATIC TYRE FILLER, 0-10 BAR**

- Calibrated version according to guideline 86/217/EWG
- Rubber-sheathed gauge
- With flexible 400 mm hose
- Measuring / filling range 0 - 10 bar



25032L 40,90 EUR*

SW STAHL **TYRE AIR PRESSURE TESTER, 0.2-10 BAR, DIGITAL**

Digital, measurements can be displayed in bar, psi, kPa, kg/cm²

- Tolerance +/- 1psi / 0,07 bar
- Maximum pressure: 10 bar



72335L 9,20 EUR*

SW STAHL **PNEUMATIC TYRE FILLER, DIGITAL, 0-14 BAR**

- Easy and optimal readability even in poor lighting conditions
- Blue illumination of the display
- Battery indicator in the display
- Rubber casing protects the pressure gauge from light impacts
- Handle with operating lever for filling and deaerator button for one-handed operation
- Hose with integrated torque plug nipple
- Integrated suspension device
- Coupling plug: integrated



25100L 38,50 EUR*

SW STAHL **HOSE WITH TYRE VALVE CONNECTOR, 1000 MM**

For tyre filler, suitable for 25030L, 25032L, 25034L, 25100L

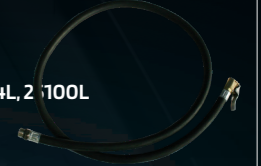

25038L 9,10 EUR*

SW STAHL **HOSE WITH TYRE VALVE CONNECTOR**

For tyre filler, suitable for 25030L, 25032L, 25034L, 25100L



25130L 26,00 EUR*

SW STAHL **TYRE VALVE CONNECTOR, 8 MM**

25131L 4,10 EUR*



SW STAHL **TYRE VALVE CONNECTOR, 6 MM**

- Clip-on chuck
- Brass, 6 mm

25031L 4,10 EUR*

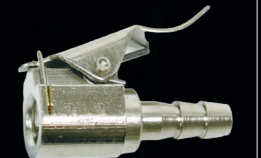

SW STAHL **TYRE AIR PRESSURE TESTER**

made of plastic.



72330L 5,10 EUR*

SW STAHL TYRE PRESSURE SENSOR TOOL SET, 14-PIECE

Suitable for TPMS, for mounting and disassembling tyre pressure control systems. Includes:

- Torque spanner 6.3 mm (1/4") 2-10 Nm, pitch 0.5 Nm, fine scale 0.1 Nm for fastening the metal valve to the rim
- Torque screwdriver 1.4 Nm with 4 mm hexagon socket for mounting the RDC sensor on the valve
- Valve sealing tool for damage-free mounting and dismantling of rubber seals on TPMS valves
- Torque-limited valve screwdriver 0.25 Nm and 0.45 Nm
- Pin punch for bracing
- Long bit 11 mm and 12 mm
- Screwdriver bits T10, T15, T20



02129L 167,00 EUR*

SW STAHL VALVE INSERTING TOOL SET, 2-PIECE

With torque limiting. This ensures proper seating and prevents the delicate valves from being turned too far.

- 0.25 Nm screwdriver for rubber valves
- 0.45 Nm screwdriver for metal valves



02000L 17,70 EUR*

SW STAHL VALVE INSERTING TOOL, 0,25 NM

the integrated torque limitation ensures a reliable fit and prevents sensitive valves from being overwound.



02025L 9,30 EUR*

SW STAHL VALVE INSERTING TOOL, 0,45 NM

the integrated torque limitation ensures a reliable fit and prevents sensitive valves from being overwound.



02045L 9,30 EUR*

SW STAHL VALVE TOOL SET, 2-PIECE

for fitting and removing valve inserts.



02110L 8,20 EUR*

SW STAHL VALVE LATHE TOOL FOR STEEL VALVES

eases the installation and removal of steel valves, e.g. on alloy wheels, rims on transporters and mobile homes (the manufacturers recommend the use of steel valves to prevent pressure loss here).

- With guide pins - prevents slipping off
- Tightening feasible with torque wrench



02112L 10,40 EUR*

SW STAHL TYRE VALVE STEM INSERTION TOOL, 300 MM

For inserting new valves into the valve hole on the rim when fitting tubeless tyres. The tool features a 2-component support piece for even better protection of aluminium and steel rims while working.

- Material: S45C, chrome-plated
- Length: 300 mm



02117L 11,40 EUR*

SW STAHL TYRE VALVE STEM FITTING TOOL, 300 MM

For inserting new valves into the valve hole of rims on tubeless tyres.



02116L 6,20 EUR*

SW STAHL TYRE VALVE STEM FITTING TOOL, 330 MM

For inserting new valves into the valve hole of rims on tubeless tyres. Suitable for all rims, with extra wide support to protect the rim edge from damage.



02115L 8,20 EUR*

SW STAHL TYRE PROFILE DEPTH GAUGE, DIGITAL

- Digital
- Measuring range from 0.00 to 28 mm
- Display can be switched from metric / inches
- Including battery LR44 digital



72315SB 8,20 EUR*

SW STAHL TREAD DEPTH GAUGE

for precise determination of the tread depth for trucks, passenger cars and motorbikes.

- Sturdy brass version
- 50 mm measuring depth
- Scale marking 1/10 mm
- Made in Germany



72311L 12,50 EUR*

SW STAHL UNIVERSAL BALANCE WEIGHT PLIERS, 245 MM

For loosening lead weights on rims. Chrome-plated, handles insulated



41440L 13,50 EUR*

SW ADHESIVE WEIGHTS

for balancing aluminium rims.

- Made of steel
- Self-adhesive
- 60 g bars with 12 weights à 5 g which can be separated off
- 50 bars
- Size (5g) 19.2 x 11.6 x 4 mm



41441L 20,90 EUR*

SW STRIPE OFF WHEEL, 90 MM

For fitting to drills.

- Fully removing adhesive residues
- 6 mm adapter with threaded connection 5/16" x 24
- Disc size: 90 x 15 mm
- Speed: max. 4,000 rpm



94857L 7,70 EUR*

SW REMOVAL DISC, M8

with M8 thread

- Wheel circumference: 90 x 15 mm
- Speed: max. 4,000 rpm



94858L 8,10 EUR*

SW TYRE BEAD CLAMP

- To facilitate tyre mounting/demounting
- Pushes the upper tyre bead into the drop centre
- Ideal for mounting run-flat and low profile tyres
- Can be used with all tyre fitting machines
- Gentle on rims
- Made of robust plastic



02180L 15,20 EUR*

SW GLUED WEIGHT REMOVER

Professional version

- Almost indestructible
- Solvent-resistant
- Can be reground by means of file
- Surfaces are not damaged



94850L 4,40 EUR*

SW PLASTIC SCRAPER SET, 4-PIECE

Ideal for removing adhesive balance weights from aluminium rims on cars and motorcycles and for removing adhesive protective strips from car bodies.

- Virtually indestructible!
- Solvent-resistant
- Removal area can be resharpened with a file
- Causes no damage to surfaces



94855L 9,70 EUR*

SW ALLOY WHEEL EDGE PROTECTOR

To avoid scratches and damage during tyre fitting and removal on aluminium wheels when using a tyre lever. The 350 mm cord is ideal for pulling the edge protection out if it slips between the tyre and the rim during fitting.



02160L 10,40 EUR*

SW TYRE LEVER

forged



250 MM

02150L 6,20 EUR*

400 MM

02151L 7,20 EUR*

500 MM

02152L 9,30 EUR*

700 MM

02153L 15,60 EUR*

SW TYRE LEVER, 390 MM

The length of 390 mm combined with the ergonomic handle reduces fatigue during the busy season, even if the tool is used continually.



02156L 13,50 EUR*

SW TYRE LEVER, 500 MM

Ideal for fitting and removing run-flat tyres. The special shape allows you to press down the tyre bead by hand without damaging the rim and prevents lip damage on run-flat tyres.

- 30% fibreglass



02162L 21,50 EUR*

SW TYRE LEVER, 380 MM

- With replaceable protection
- For damage-free tyre fitting on aluminium rims
- The plastic top cover is fastened on the steel core by using 3 screws

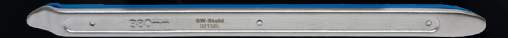

02158L 12,50 EUR*

SW TYRE LEVER, 500 MM

with replaceable protection, for damage-free tyre fitting on aluminium rims.

- The replaceable plastic cover is attached to the steel core using 3 screws



02154L 20,90 EUR*

SW TYRE LEVER, 650 MM

- Specially shaped
- Heavy version for commercial vehicles, agricultural and construction machinery
- Chromium vanadium
- 650 mm long



02161L 27,00 EUR*

SW TYRE LEVER, 1,000 MM

- Special shape
- Heavy-duty version for commercial vehicles agricultural and construction machinery
- Chromium vanadium
- Length 1,000 mm



02163L 41,90 EUR*

EVERYTHING AT A GLANCE!?

WITH OUR NEWSLETTER, YOU WON'T MISS OUT ON ANY EXCITING INFORMATION OR BARGAINS.

SIGN UP NOW AT:



SW STAHL
PROFESSIONAL TOOLS

SW STAHL FITTING PASTE, 5 KG

for the fast, gentle and easy fitting and removal of all standard wheel/tyre combinations including run-flat tyres and PAX tyres.

- Chemically neutral to rubber and metal
- The high sliding effect during fitting and removal reduces fitting injuries
- Promotes the interlocking between rim and tyre
- 100% biologically degradable
- 100% guarantee of no contact allergies for fitters
- Antifreeze-safe, processing temperature from -15°C to +50°C
- Very efficient
- Centrifuge-resistant
- Color white



02132L 12,50 EUR*

SW STAHL FITTING PASTE, 3 KG

for the fast, gentle and easy fitting and removal of all standard wheel/tyre combinations including run-flat tyres and PAX tyres.



02130L 9,30 EUR*

SW STAHL BRUSH

With round head for better application of assembly paste.



02135L 12,50 EUR*

SW STAHL ALUMINIUM WHEEL HUB CLEANER

Cleaning of wheel hubs and other flat surfaces. Removes corrosion on the contact surfaces between the wheel hub and rim.

- High-strength aluminium with steel core
- Extremely high impact resistance
- Extremely high abrasion and wear resistance
- Maximum speed of 4,000 rpm
- Sturdy Velcro fastener for quick change of grinding wheels



302230L 59,90 EUR*

SW STAHL WHEEL HUB GRINDER REPLACEMENT CLEANING DISCS, SET OF 2

For wheel hub grinder 302230L. Corrosion between the rim and the wheel hub is removed and torque values can no longer be distorted.

- Inner diameter 90 mm
- Outer diameter 150 mm

Also suitable for the latest wheel hubs with an enlarged inner diameter, e.g. on: BMW 1 Series (E81, E82, E87, E88, F20, F21).

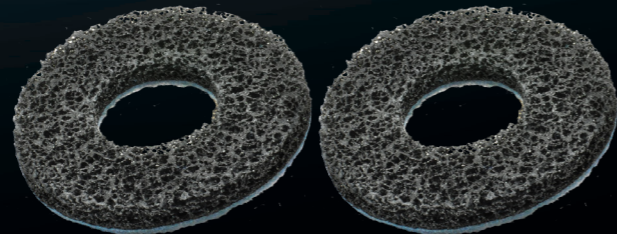

302230L-1 26,00 EUR*

SW STAHL WHEEL HUB CLEANER SET, 10-PIECE

suitable for wheel hubs with stud bolts.

Content:

- 1 base made of plastic, with hexagon
- 8 grinding wheels, each 40 mm in diameter
- 1 adapter 12,5 mm (1/2")



10359L 26,90 EUR*

SW STAHL BOLT CLEANING SET, 1/2", 1/4", CAR, 8-PIECE

For quick and easy cleaning of screws, studs or wheel bolts

The set includes the following brush attachments (1 each):

- Brush attachment 12 mm (7/16")
- Brush attachment 13 mm (1/2")
- Brush attachment 14 mm (9/16")
- Brush attachment 16 mm (5/8")
- Brush attachment 18 mm (45/64")
- Brush attachment 22 mm (55/64")
- Quick switch brush adapter 1/2"
- 1/2" to 1/4" adapter for use on a cordless screwdriver



10358L 31,50 EUR*

SW STAHL BRUSH SET FOR DRILLING MACHINES, 4-PIECE

Content:

- Suitable for all indoor and outdoor cleaning projects
- Especially for rim cleaning
- 1/4" Holder for cordless drills
- Durable nylon bristles
- Brush attachment with diameter 4,9 cm
- Brush attachment with diameter 8,4 cm
- Brush attachment with diameter 10 cm
- Brush attachment with diameter 12 cm



62400L 15,60 EUR*

SW STAHL NON-RECOIL HAMMER, 2,100 G

non-recoil, completely rubberised.

- Made of polyurethane glass fibre
- The steel balls in the hammer head prevent the hammer recoiling
- Especially for use during tyre changing, for loosening rims that have become rusted tight



51113L 26,50 EUR*

SW STAHL NON-RECOIL HAMMER, 5.250 G

non-recoil, completely rubberised.

- Made of polyurethane glass fibre
- The steel balls in the hammer head prevent the hammer recoiling
- Especially for use during tyre changing, for loosening rims that have become rusted tight



51115L 47,50 EUR*

SW STAHL HANDHELD LAMP, 1,200 LUMEN

The portable hand lamp with COB technology is virtually indestructible thanks to the use of a metal housing with a polycarbonate cover. It is splash-proof and shines particularly brightly with 1,200 lumens. The integrated Li-Ion rechargeable battery provides enough power for a long working day and is durable and environmentally friendly thanks to the latest technology.

- With emergency light operation for several hours
- Shatterproof from a height of up to 2 metres
- Splash-proof, IP54
- Charging station with wall mounting option
- USB charging cable with AC/DC adapter
- 2 neodymium magnets on fold-out light support



S9790 51,50 EUR*

SW STAHL INSPECTION LAMP, 550 LUMEN

The ergonomically designed LED inspection lamp with SMD technology is your reliable companion throughout the day. The use of high-quality materials, such as aluminium and polycarbonate, makes the lamp virtually indestructible and ensures user safety during operation. The lamp can be mounted quickly and securely using the practical clip hook and a strong neodymium magnet.

- Shatterproof from up to 3 metres height
- USB charging cable with AC/DC adapter
- Clip hook with neodymium magnet



S9791 35,90 EUR*

SW STAHL LED BATTERY HEAD LAMP, 2W COB

- Powerful, flicker-free light with 2W COB LED
- Low heat generation and uniform light distribution
- Dimensions approx. 100 x 50 x 40 mm
- 2-level adjustable lighting
- Excellent fit with adjustable rubber band
- Luminous flux 100 Lm (level 1) or 180 Lm (level 2)
- Integrated 3.7V / 1800 m Ah Li-Ion battery
- Incl. USB-charging cable with adapter for socket



S9716 15,50 EUR*

SW STAHL WORK PLATFORM, MADE OF ALUMINIUM, FOLDABLE

Convenient working platform for hard-to-reach spaces.

- Dimensions 127 x 44.5 x 49.5 cm (L x W x H)
- Folds away to save space
- Sturdy aluminium design
- Non-slip platform surface
- Maximum load 150 kg



20920L 102,90 EUR*

SW STAHL STEP LADDER, MADE OF ALUMINIUM, FOLDABLE, 3-STEP

- Max. load: 150 kg
- Made of aluminium
- Weight: 2.60 kg

Dimensions:

- Unfolded: 400 x 180 x 230 mm
- Folded: 400 x 270 x 280 mm



20922L 61,90 EUR*

SW STAHL CREEPER FOR SITTING OR LYING DOWN

- Durable imitation leather cover
- Lockable in sitting and reclining position
- Size: 1000 x 430 mm
- Reclining height: 110 mm
- 6 swivel castors
- Load capacity 140 kg

Seat surface: 310 x 280 mm
Lying surface: 400 mm
Seat height: 1000 x 280 mm (upholstered surface)



20925L 52,90 EUR*

SW STAHL CREEPER

made of plastic, ergonomically formed, with utility boxes for consumables at the side.

- 6 casters
- 130 kg capacity



20950L 41,00 EUR*

SW STAHL KNEE PAD

- With small parts compartment made of solvent-resistant foam
- With practical handle
- Overall dimensions: 475 x 310 x 35 mm



07370L 11,60 EUR*

SW STAHL ROLLER SEAT

- Made of plastic, black, with 4 casters
- Base can be used as tool tray
- Seat height 290 mm
- Capacity up to 160 kg



20915L 31,90 EUR*

SW STAHL TROLLEY JACK, 3 T

- Hydraulic double piston mechanism
- Quick lifting - effortless
- Very low in weight but sturdy
- With rubber pad on bearing area
- With rod protection on piston rod
- Lifting height: 130 - 465 mm
- Carrying load: 3,000 kg
- Wheels made of steel



20731L 212,00 EUR*

SW STAHL TROLLEY JACK, 3T

- Hydraulic double piston mechanism
- Quick lifting - effortless
- Very low in weight but sturdy
- With rubber pad on bearing area
- With rod protection on piston rod
- Lifting height: 100 - 535 mm
- carrying load: 3000 kg



20741L 236,90 EUR*

SW STAHL HYDRAULIC BOTTLE JAC



20601L	HYDRAULIC BOTTLE JACK, 2 T, LIFTING HEIGHT 168 - 316 MM	21,00 EUR*
20602L	HYDRAULIC BOTTLE JACK, 5 T, LIFTING HEIGHT 207 - 402 MM	25,50 EUR*
20605L	HYDRAULIC BOTTLE JACK, 12 T, LIFTING HEIGHT 227 - 457 MM	42,50 EUR*
20606L	HYDRAULIC BOTTLE JACK, 20 T, LIFTING HEIGHT 235 - 445 MM	52,90 EUR*

SW STAHL TROLLEY JACK, 2 T

- Load capacity 2,000 kg
- Single Lifting height: 135 - 340 mm
- With casters and safety valve



20700L 56,50 EUR*

SW STAHL SUPPORT STAND, 1 PIECE

with one-hand operation, four legs



20460L	3 TONS, 1 PIECE, HEIGHT FROM 280 MM TO 420 MM	26,50 EUR*
20470L	6 TONS, 1 PIECE, HEIGHT FROM 385 MM TO 600 MM	48,90 EUR*

SW STAHL SUPPORT STAND, 1 PAIR

with one-hand operation, four legs



20465L	3 TONS, 2 PIECES, HEIGHT FROM 280 MM TO 420 MM	42,50 EUR*
20475L	6 TONS, 2 PIECES, HEIGHT FROM 385 MM TO 600 MM	72,00 EUR*

SW STAHL TROLLEY JACK, FOR TYRES UP TO 300 MM

for simple vehicle lifting without touching the chassis or body.

- The use of four trolley jacks allows you to position and turn the vehicle as required
- Load-bearing capacity 680 kg / 2,720 kg when four trolley jacks are used
- Hydraulic cylinder operated by foot pedal

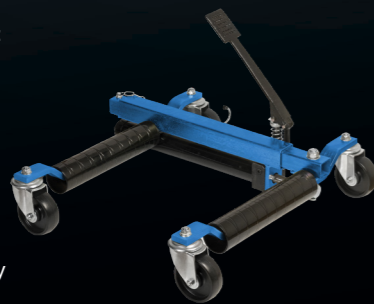

20723L 190,90 EUR*

SW STAHL TROLLEY JACK, FOR TYRES UP TO 225 MM

for simple vehicle lifting without touching the chassis or body.

- The use of four trolley jacks allows you to position and turn the vehicle as required
- Load-bearing capacity 680 kg / 2,720 kg when four trolley jacks are used
- Hydraulic cylinder operated by foot pedal



20720L 180,50 EUR*

SW STAHL TROLLEY JACK, HYDRAULIC, WITH FOOT PEDAL, 2.25T

- Load capacity: 2250 kg
- Lifting height: 140 - 490 mm
- With quick foot lift
- Stop protection on the piston rod
- Steel wheels



20819L 154,50 EUR*

SW STAHL TROLLEY JACK, HYDRAULIC, WITH FOOT PEDAL, 2.5T

- Load capacity: 2500 kg
- Low profile - low clearance height
- Lifting height: 75 - 505 mm
- Hydraulic double piston mechanism
- Fast lifting - low effort required
- With foot-operated quick lift
- Includes rubber pad on the contact surface
- Impact protection on the piston rod



20823L 201,50 EUR*

SW STAHL SCISSORS-TYPE JACK, 1,5 T

with crank.

- Lifting power: 100 - 360 mm
- Heavy load: 1500 kg

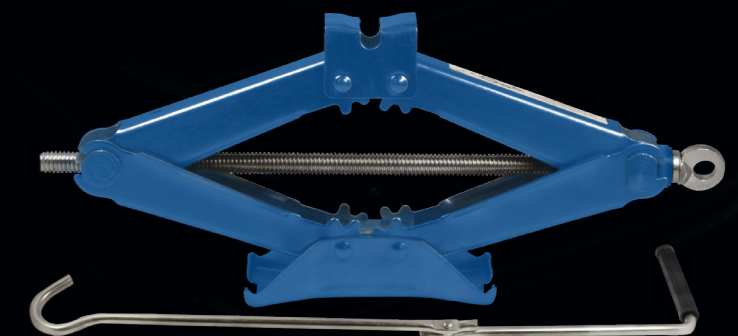

22201L 26,00 EUR*

CHANGING MADE EASY—
TOOLS THAT REALLY HELP!

WINNING DESIGN. PROVEN PERFORMANCE!



reddot winner 2025



SW STAHL PNEUMATIC IMPACT WRENCH

- High performance twin hammer mechanism
- Threefold torque selection
- Max. torque 3rd speed: 1.200 Nm
- Max. release torque: 1.800 Nm
- Fatigue-proof work due to low net weight
- Single handed switching for clockwise/anticlockwise running
- Very low vibration
- Ergonomic 2-component (TPR+Nylon) handle with special non-slip texture
- 1/4" inlet nipple included

DESIGNED
IN GERMANY



DOWNLOAD
BROCHURE



1/2", 1.800 NM

S3460 66,90 EUR*

1/2", 1.300 NM, 118 MM

S3465 72,00 EUR*

3/4", 1.900 NM

S3470 72,00 EUR*